



ATIVIDADE DE REVISÃO

1º ano

**Português**

1. Complete o alfabeto com as letras cursivas faltosas:



Alfabeto maiúsculo

A	_____	C	_____	E	_____	G	_____
H	_____	I	_____	L	_____	N	_____
O	_____	Q	_____	S	_____	U	_____
V	_____	X	_____	Z	_____		



Alfabeto minúsculo

a	_____	c	_____	e	_____	g	_____
h	_____	j	_____	l	_____	n	_____
o	_____	q	_____	s	_____	u	_____
v	_____	x	_____	z	_____		

Meu nome:



ATIVIDADE DE REVISÃO

1º ano

# Matemática



QUEM VEM ANTES?

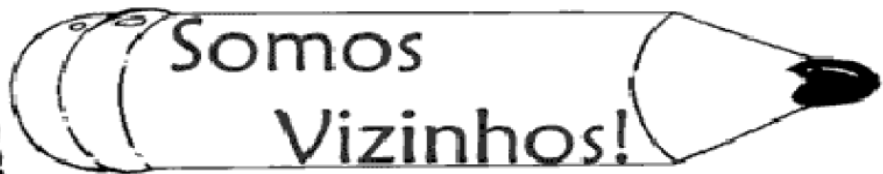

← 7       ← 2       ← 9

QUEM VEM DEPOIS?

4 →       2 →       0 →

QUEM ESTÁ ENTRE?

<input type="text"/> 3 ← <input type="text"/> → 5	<input type="text"/> 7 ← <input type="text"/> → 9
<input type="text"/> 0 ← <input type="text"/> → 2	<input type="text"/> 4 ← <input type="text"/> → 6
<input type="text"/> 6 ← <input type="text"/> → 8	<input type="text"/> 1 ← <input type="text"/> → 3

Meu nome:



ATIVIDADE DE REVISÃO

1º ano

**Português**

**DITADO NUMÉRICO**

Forme palavras, procurando os numerais iguais.

1	2	2	1	6	4	3
PI	PO	PI	CO	PA	PI	ÃO
5	1	3	6	2	6	4
PÃO	LÉ	PI	NE	CA	LA	PA



1 \_\_\_\_\_



2 \_\_\_\_\_



3 \_\_\_\_\_

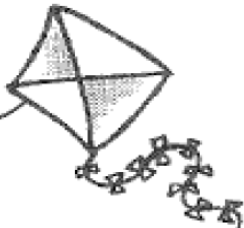

4 \_\_\_\_\_



5 \_\_\_\_\_



6 \_\_\_\_\_

Meu nome:



ATIVIDADE DE REVISÃO

1º ano

**Português**

1 BA	2 BO	3 FU	4 DO	5 LA
6 CU	7 MA	8 PI	9 NE	10 TA
11 CE	12 PO	13 ÇA	14 VE	15 PE
16 FI	17 LA	18 TE	19 BA	20 CA

1 + 5	
2 + 5	
1 + 10	
1 + 19	
2 + 9 + 20	

NOME	
------	--



ATIVIDADE DE REVISÃO

1º ano

# Matemática



CADA CONJUNTO UMA QUANTIDADE

1) CIRCULE O NUMERAL CORRESPONDENTE AOS ELEMENTOS DE CADA CONJUNTO.

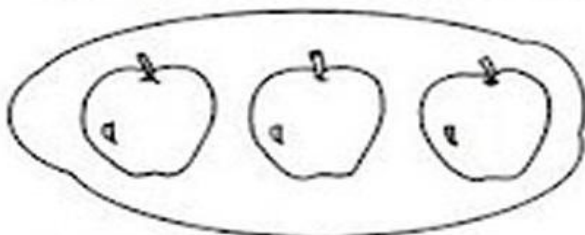

6 - 9 - 3 - 1



2 - 7 - 4 - 5



8 - 6 - 9 - 7



4 - 3 - 5 - 1

2) COMPLETE OS CONJUNTOS PARA QUE FIQUEM COM AS QUANTIDADES PEDIDAS.

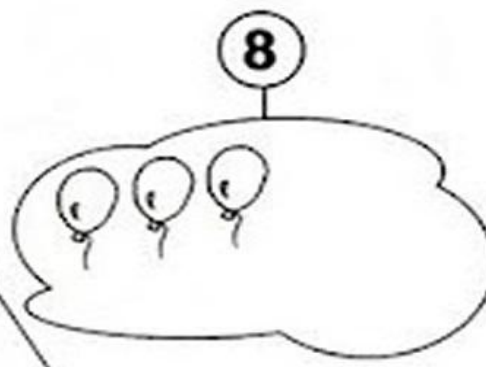
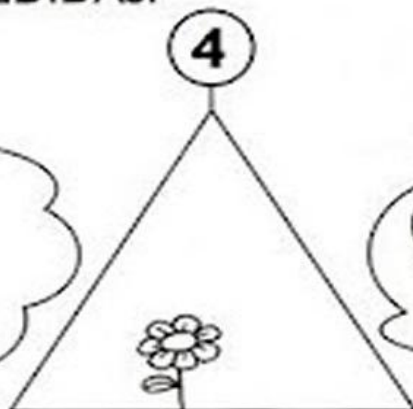
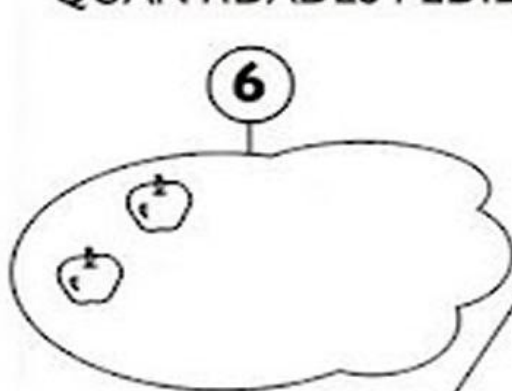

Meu nome:



ATIVIDADE DE REVISÃO

1º ano

Português

# DiTADO SIMBÓLICO

Junte os símbolos e forme palavras.

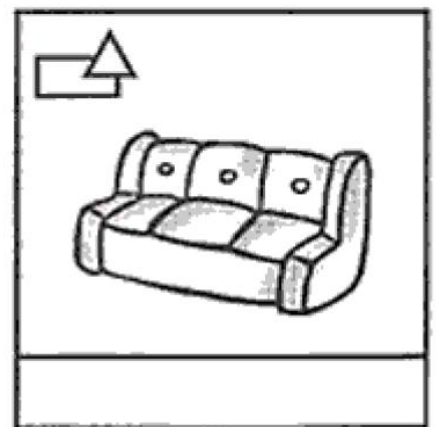
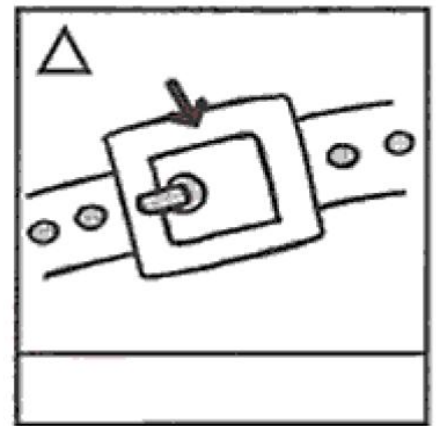
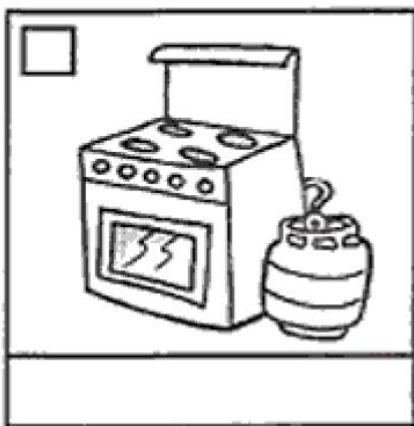

Meu nome:



ATIVIDADE DE REVISÃO

1º ano

# Matemática

1- COMPLETE OS VAGÕES DOS TRENS COM OS NUMERAIS EM SEQUÊNCIA:

ORDEM CRESCENTE

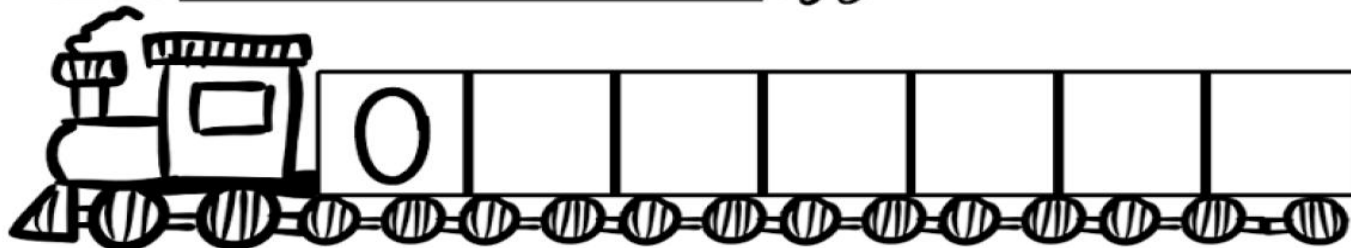

ORDEM DECRESCENTE

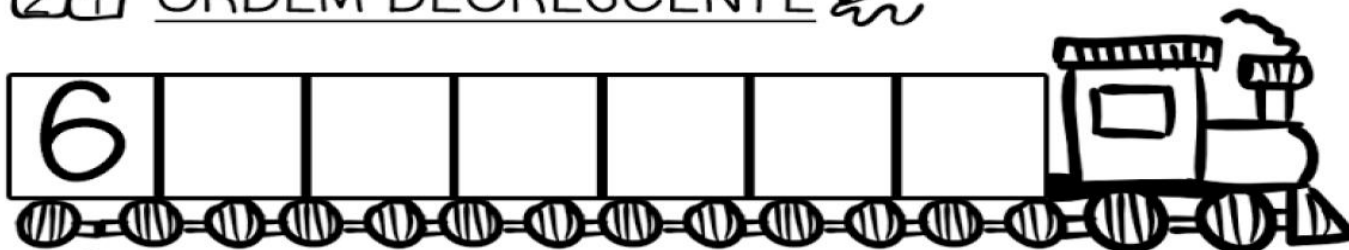

ORDEM CRESCENTE

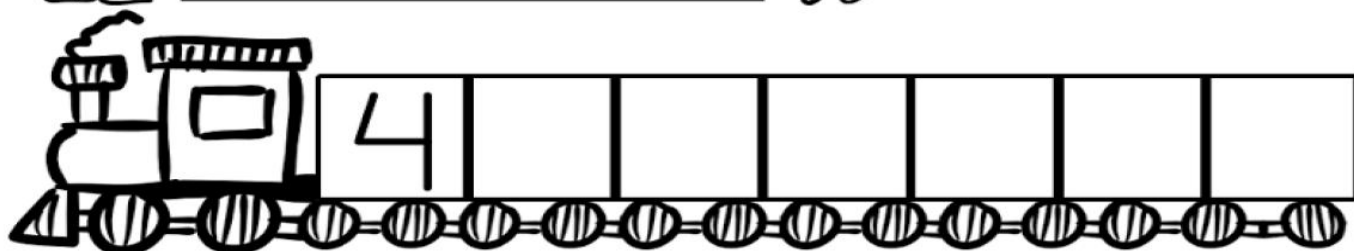

ORDEM DECRESCENTE

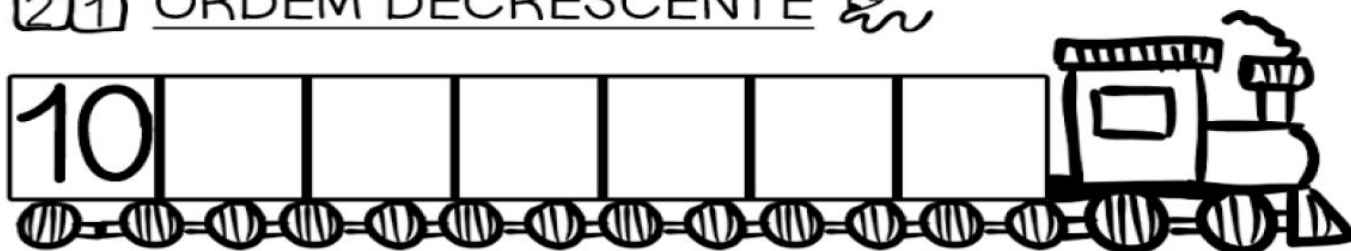

Meu nome:



ATIVIDADE DE REVISÃO

1º ano

**Português**

**PINTA-NOMES**

PINTE OS NOMES DAS FIGURAS.



GATO

PATO

MATO



FACA

LATA

MACA

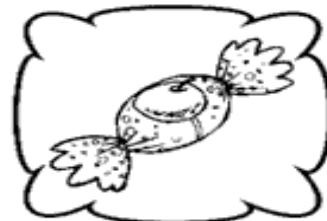

BALA

MALA

RALA

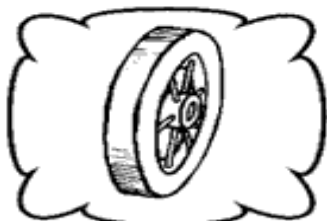

ROMA

ROSA

RODA



FURE

BULE

PULE

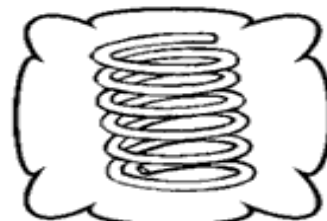

COLA

GOLA

MOLA



RUA

NUA

LUA

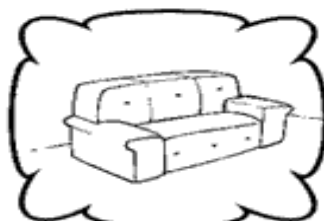

SOFÁ

SALA

SOLA



POTE

GOLE

FOLE

Meu nome:

**#ficaemcasa**

Coordenação Pedagógica



ATIVIDADE DE REVISÃO

1º ano

**Português**

ESCREVA SEU NOME.

AGORA ESCREVA NOS QUADRADINHOS:

QUANTAS LETRAS TEM SEU NOME?

QUAL É A PRIMEIRA LETRA DO SEU NOME?

QUAL É A ÚLTIMA LETRA DO SEU NOME?

TEM LETRAS QUE SE REPETEM?

QUANTAS VOGAIS TEM SEU NOME?

QUANTAS CONSOANTES TEM SEU NOME?

Meu nome:



ATIVIDADE DE REVISÃO

1º ano

**Português**

**OLHO VIVO!**

Junte as sílabas e escreva os nomes dos desenhos.

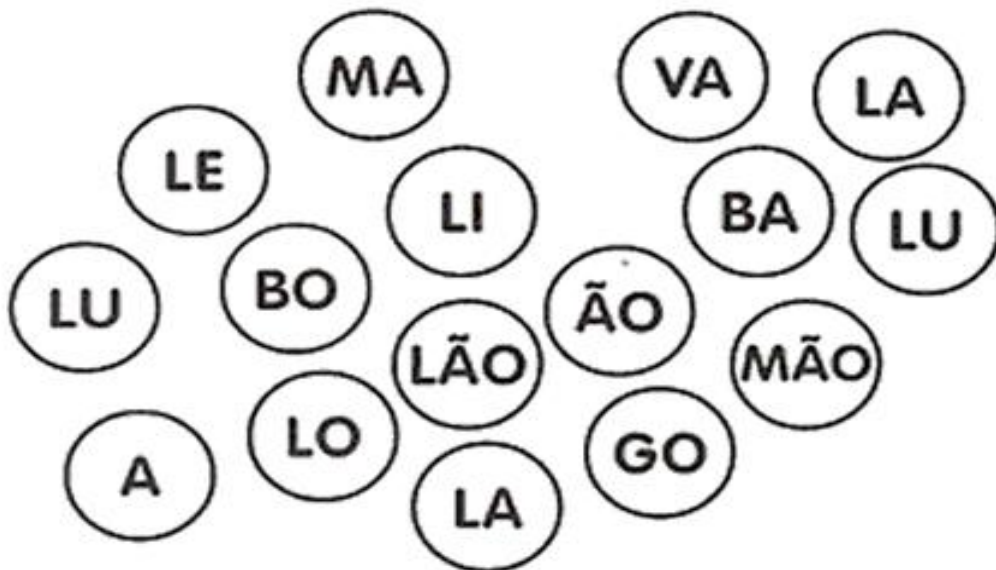







Meu nome:

ATIVIDADE DE REVISÃO

1º ano

**Português**

Leia as sílabas abaixo, depois circule-as nas palavras.

	da	de	di	do	du	
	Da	De	Di	Do	Du	
						
cadeado	cabide	Duda	doce			

Cubra o pontilhado das sílabas da letra D.

da	de	di	do	du
Da	De	Di	Do	Du

Escreva várias vezes as sílabas abaixo.

da	<input type="text"/>
de	<input type="text"/>
di	<input type="text"/>
do	<input type="text"/>
du	<input type="text"/>



Meu nome:



ATIVIDADE DE REVISÃO  
**Português**

**1º ano**

Cubra e copie.

Handwriting practice grid with four rows:

- Row 1: Tracing of lowercase 'f' and uppercase 'F' on a four-line grid.
- Row 2: Tracing of syllables 'fa', 'fe', 'fi', 'fo', 'fu' on a four-line grid.
- Row 3: Blank four-line grid for independent practice.
- Row 4: Tracing of words 'fa', 'fe', 'fi', 'fo', 'fu' on a four-line grid.

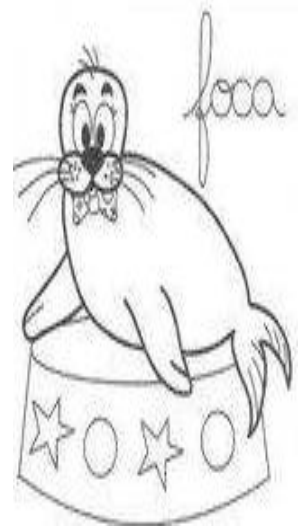

Junte e copie a

família do F.

Activity for identifying words starting with 'F':

- A large outline of the letter 'F' is shown.
- Two cartoon children are holding books.
- A central circle contains the letter 'F', with lines connecting it to five smaller circles containing the vowels 'A', 'E', 'I', 'O', and 'U'.
- To the right of these circles is a 5x3 grid of empty rounded rectangles for writing words.

Meu nome:

Empty rounded rectangular box for writing the student's name.











ATIVIDADE DE REVISÃO





1º ano





# Matemática





## Desafio da adição!





 +  =   
\_\_\_\_ + \_\_\_\_ = 

 +  =   
\_\_\_\_ + \_\_\_\_ = 

 +  =   
\_\_\_\_ + \_\_\_\_ = 

 +  =   
\_\_\_\_ + \_\_\_\_ = 

 +  =   
\_\_\_\_ + \_\_\_\_ = 

 +  =   
\_\_\_\_ + \_\_\_\_ = 

Meu nome:



ATIVIDADE DE REVISÃO

1º ano

**Português**

1- JUNTE AS SÍLABAS, FORME PALAVRAS, COPIE E LEIA. DIGA QUANTOS SONS TEM CADA UMA.

BO — LA \_\_\_\_\_

BO — NÉ \_\_\_\_\_

BO — NE CA \_\_\_\_\_

---

PE — LE \_\_\_\_\_

PE — TE CA \_\_\_\_\_

PE — NA \_\_\_\_\_

---

LU — A \_\_\_\_\_

LU — VA \_\_\_\_\_

LU — NE TA \_\_\_\_\_

Meu nome:



ATIVIDADE DE REVISÃO

1º ano

# Matemática

## COMPLETE



$6 + 2 = \square$

$3 + 2 = \square$

$4 + 3 = \square$

$8 + 1 = \square$

$5 + 2 = \square$

$6 + 3 = \square$

$7 + 2 = \square$

$2 + 2 = \square$

$4 + 4 = \square$

$4 + 6 = \square$

-----

$3 + \square = 4$

$\square + 6 = 9$

$\square + 4 = 6$

$5 + \square = 14$

$5 + \square = 8$

$\square + 4 = 10$

$\square + 3 = 7$

$2 + \square = 7$

$2 + \square = 5$

$\square + 5 = 12$



Meu nome:



































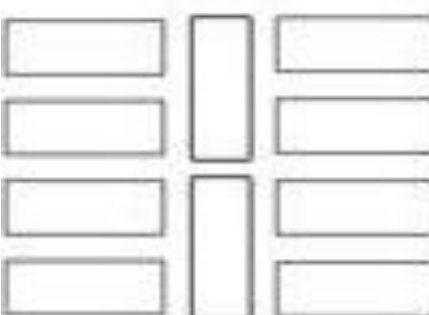

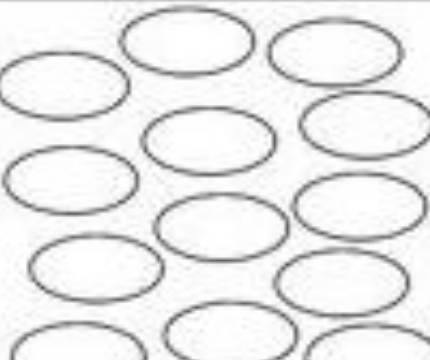

ATIVIDADE DE REVISÃO

1º ano

# Matemática

Conte e circule o número correto.

Meu nome:



ATIVIDADE DE REVISÃO

1º ano

# Matemática

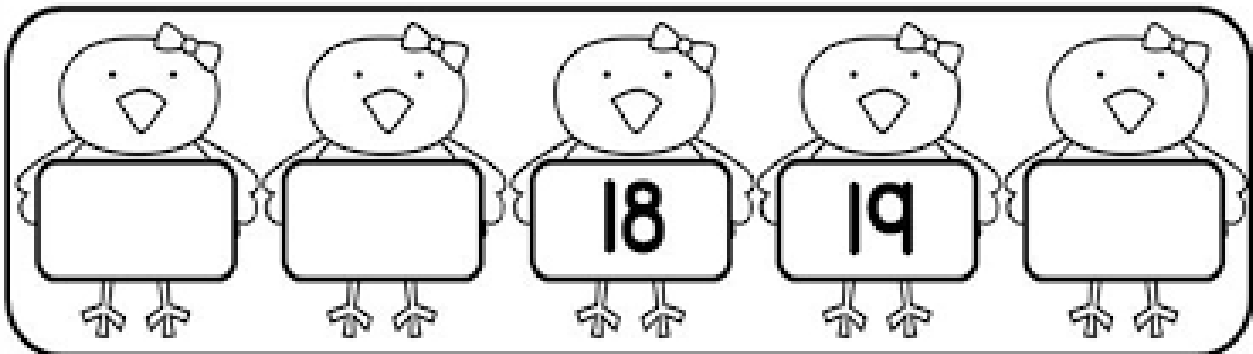
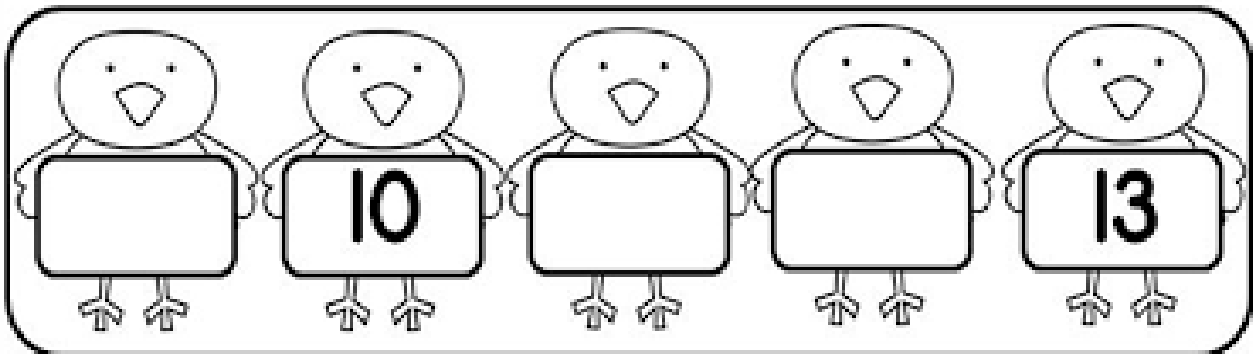
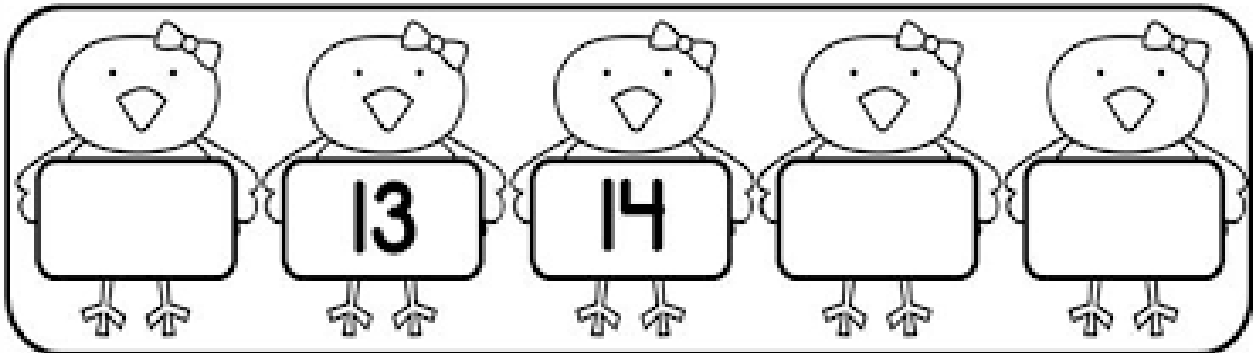
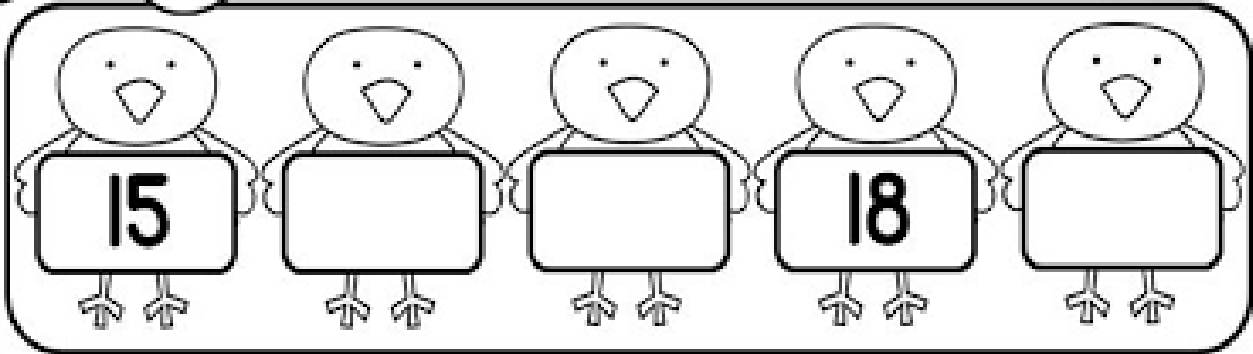

Meu nome:

